



BRAKE SHOES

Replace the brake shoes if the indicator plate aligns with the brake panel index mark when the rear brake lever or pedal is applied.



INDEX MARK

INDICATOR PLATE

**STEERING SYSTEM
(TOE/CAMBER/CASTER)**

TOE-IN

Place the vehicle on level ground with the front wheels facing straight ahead.
Mark the centers of the tires with chalk to indicate the axle center height.

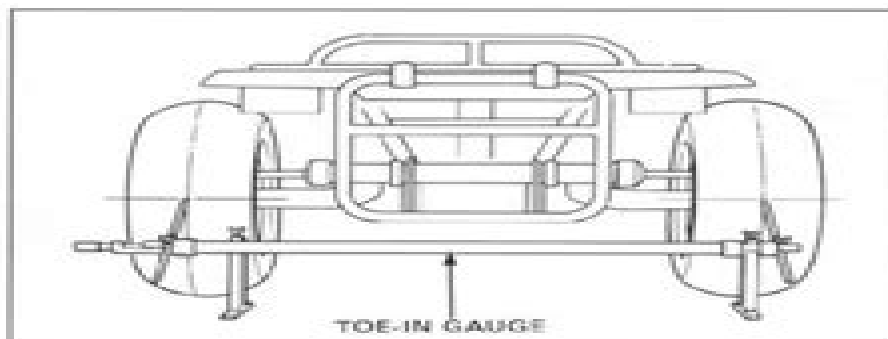

TOE-IN GAUGE

Align the toe-in gauge with the marks on the tires as shown.
Check the readings on the gauges scales.
Slowly move the vehicle back until the wheels have turned 180° so the marks on the tires are aligned with the gauge height on the rear side.
Measure the toe-in on the rear part of the tires at the same points.

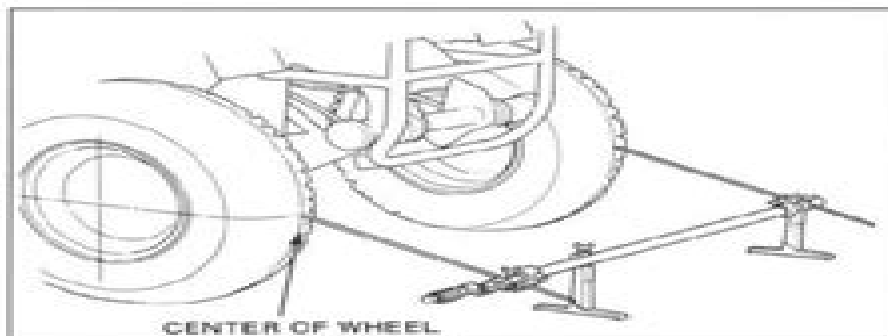

CENTER OF WHEEL

Trx 3honda Work Shop Manual

O García



Trx 3honda Work Shop Manual:

The Engaging World of Kindle Books: A Comprehensive Guide Revealing the Pros of E-book Books: A World of Ease and Versatility E-book books, with their inherent mobility and ease of access, have freed readers from the limitations of hardcopy books. Gone are the days of lugging bulky novels or carefully searching for particular titles in bookstores. E-book devices, sleek and portable, seamlessly store an extensive library of books, allowing readers to immerse in their preferred reads anytime, everywhere. Whether traveling on a busy train, relaxing on a sun-kissed beach, or just cozying up in bed, E-book books provide an exceptional level of convenience. A Reading Universe Unfolded: Discovering the Wide Array of E-book Trx 3honda Work Shop Manual Trx 3honda Work Shop Manual The E-book Shop, a virtual treasure trove of bookish gems, boasts an wide collection of books spanning varied genres, catering to every readers preference and choice. From gripping fiction and thought-provoking non-fiction to timeless classics and contemporary bestsellers, the Kindle Store offers an unparalleled abundance of titles to discover. Whether looking for escape through engrossing tales of fantasy and exploration, diving into the depths of historical narratives, or broadening ones understanding with insightful works of science and philosophical, the E-book Shop provides a doorway to a literary world brimming with endless possibilities. A Revolutionary Force in the Bookish Scene: The Enduring Influence of E-book Books Trx 3honda Work Shop Manual The advent of E-book books has certainly reshaped the bookish landscape, introducing a paradigm shift in the way books are published, distributed, and consumed. Traditional publication houses have embraced the digital revolution, adapting their approaches to accommodate the growing demand for e-books. This has led to a rise in the accessibility of Kindle titles, ensuring that readers have entry to a vast array of bookish works at their fingertips. Moreover, Kindle books have democratized entry to books, breaking down geographical barriers and offering readers worldwide with similar opportunities to engage with the written word. Irrespective of their place or socioeconomic background, individuals can now immerse themselves in the intriguing world of literature, fostering a global community of readers. Conclusion: Embracing the E-book Experience Trx 3honda Work Shop Manual Kindle books Trx 3honda Work Shop Manual, with their inherent convenience, versatility, and vast array of titles, have certainly transformed the way we encounter literature. They offer readers the liberty to explore the boundless realm of written expression, anytime, everywhere. As we continue to navigate the ever-evolving digital landscape, Kindle books stand as testament to the persistent power of storytelling, ensuring that the joy of reading remains reachable to all.

https://letsgetcooking.org.uk/results/book-search/Download_PDFS/Writing_An_Article_Analysis_Paper.pdf

Table of Contents Trx 3honda Work Shop Manual

1. Understanding the eBook Trx 3honda Work Shop Manual
 - The Rise of Digital Reading Trx 3honda Work Shop Manual
 - Advantages of eBooks Over Traditional Books
2. Identifying Trx 3honda Work Shop Manual
 - Exploring Different Genres
 - Considering Fiction vs. Non-Fiction
 - Determining Your Reading Goals
3. Choosing the Right eBook Platform
 - Popular eBook Platforms
 - Features to Look for in an Trx 3honda Work Shop Manual
 - User-Friendly Interface
4. Exploring eBook Recommendations from Trx 3honda Work Shop Manual
 - Personalized Recommendations
 - Trx 3honda Work Shop Manual User Reviews and Ratings
 - Trx 3honda Work Shop Manual and Bestseller Lists
5. Accessing Trx 3honda Work Shop Manual Free and Paid eBooks
 - Trx 3honda Work Shop Manual Public Domain eBooks
 - Trx 3honda Work Shop Manual eBook Subscription Services
 - Trx 3honda Work Shop Manual Budget-Friendly Options
6. Navigating Trx 3honda Work Shop Manual eBook Formats
 - ePub, PDF, MOBI, and More
 - Trx 3honda Work Shop Manual Compatibility with Devices
 - Trx 3honda Work Shop Manual Enhanced eBook Features
7. Enhancing Your Reading Experience
 - Adjustable Fonts and Text Sizes of Trx 3honda Work Shop Manual
 - Highlighting and Note-Taking Trx 3honda Work Shop Manual
 - Interactive Elements Trx 3honda Work Shop Manual
8. Staying Engaged with Trx 3honda Work Shop Manual

- Joining Online Reading Communities
 - Participating in Virtual Book Clubs
 - Following Authors and Publishers Trx 3honda Work Shop Manual
9. Balancing eBooks and Physical Books Trx 3honda Work Shop Manual
- Benefits of a Digital Library
 - Creating a Diverse Reading Collection Trx 3honda Work Shop Manual
10. Overcoming Reading Challenges
- Dealing with Digital Eye Strain
 - Minimizing Distractions
 - Managing Screen Time
11. Cultivating a Reading Routine Trx 3honda Work Shop Manual
- Setting Reading Goals Trx 3honda Work Shop Manual
 - Carving Out Dedicated Reading Time
12. Sourcing Reliable Information of Trx 3honda Work Shop Manual
- Fact-Checking eBook Content of Trx 3honda Work Shop Manual
 - Distinguishing Credible Sources
13. Promoting Lifelong Learning
- Utilizing eBooks for Skill Development
 - Exploring Educational eBooks
14. Embracing eBook Trends
- Integration of Multimedia Elements
 - Interactive and Gamified eBooks

Trx 3honda Work Shop Manual Introduction

In today's digital age, the availability of Trx 3honda Work Shop Manual books and manuals for download has revolutionized the way we access information. Gone are the days of physically flipping through pages and carrying heavy textbooks or manuals. With just a few clicks, we can now access a wealth of knowledge from the comfort of our own homes or on the go. This article will explore the advantages of Trx 3honda Work Shop Manual books and manuals for download, along with some popular platforms that offer these resources. One of the significant advantages of Trx 3honda Work Shop Manual books and manuals for download is the cost-saving aspect. Traditional books and manuals can be costly, especially if you need to

purchase several of them for educational or professional purposes. By accessing Trx 3honda Work Shop Manual versions, you eliminate the need to spend money on physical copies. This not only saves you money but also reduces the environmental impact associated with book production and transportation. Furthermore, Trx 3honda Work Shop Manual books and manuals for download are incredibly convenient. With just a computer or smartphone and an internet connection, you can access a vast library of resources on any subject imaginable. Whether you're a student looking for textbooks, a professional seeking industry-specific manuals, or someone interested in self-improvement, these digital resources provide an efficient and accessible means of acquiring knowledge. Moreover, PDF books and manuals offer a range of benefits compared to other digital formats. PDF files are designed to retain their formatting regardless of the device used to open them. This ensures that the content appears exactly as intended by the author, with no loss of formatting or missing graphics. Additionally, PDF files can be easily annotated, bookmarked, and searched for specific terms, making them highly practical for studying or referencing. When it comes to accessing Trx 3honda Work Shop Manual books and manuals, several platforms offer an extensive collection of resources. One such platform is Project Gutenberg, a nonprofit organization that provides over 60,000 free eBooks. These books are primarily in the public domain, meaning they can be freely distributed and downloaded. Project Gutenberg offers a wide range of classic literature, making it an excellent resource for literature enthusiasts. Another popular platform for Trx 3honda Work Shop Manual books and manuals is Open Library. Open Library is an initiative of the Internet Archive, a non-profit organization dedicated to digitizing cultural artifacts and making them accessible to the public. Open Library hosts millions of books, including both public domain works and contemporary titles. It also allows users to borrow digital copies of certain books for a limited period, similar to a library lending system. Additionally, many universities and educational institutions have their own digital libraries that provide free access to PDF books and manuals. These libraries often offer academic texts, research papers, and technical manuals, making them invaluable resources for students and researchers. Some notable examples include MIT OpenCourseWare, which offers free access to course materials from the Massachusetts Institute of Technology, and the Digital Public Library of America, which provides a vast collection of digitized books and historical documents. In conclusion, Trx 3honda Work Shop Manual books and manuals for download have transformed the way we access information. They provide a cost-effective and convenient means of acquiring knowledge, offering the ability to access a vast library of resources at our fingertips. With platforms like Project Gutenberg, Open Library, and various digital libraries offered by educational institutions, we have access to an ever-expanding collection of books and manuals. Whether for educational, professional, or personal purposes, these digital resources serve as valuable tools for continuous learning and self-improvement. So why not take advantage of the vast world of Trx 3honda Work Shop Manual books and manuals for download and embark on your journey of knowledge?

FAQs About Trx 3honda Work Shop Manual Books

What is a Trx 3honda Work Shop Manual PDF? A PDF (Portable Document Format) is a file format developed by Adobe that preserves the layout and formatting of a document, regardless of the software, hardware, or operating system used to view or print it. **How do I create a Trx 3honda Work Shop Manual PDF?** There are several ways to create a PDF: Use software like Adobe Acrobat, Microsoft Word, or Google Docs, which often have built-in PDF creation tools. **Print to PDF:** Many applications and operating systems have a "Print to PDF" option that allows you to save a document as a PDF file instead of printing it on paper. **Online converters:** There are various online tools that can convert different file types to PDF. **How do I edit a Trx 3honda Work Shop Manual PDF?** Editing a PDF can be done with software like Adobe Acrobat, which allows direct editing of text, images, and other elements within the PDF. Some free tools, like PDFescape or Smallpdf, also offer basic editing capabilities. **How do I convert a Trx 3honda Work Shop Manual PDF to another file format?** There are multiple ways to convert a PDF to another format: Use online converters like Smallpdf, Zamzar, or Adobe Acrobat's export feature to convert PDFs to formats like Word, Excel, JPEG, etc. Software like Adobe Acrobat, Microsoft Word, or other PDF editors may have options to export or save PDFs in different formats. **How do I password-protect a Trx 3honda Work Shop Manual PDF?** Most PDF editing software allows you to add password protection. In Adobe Acrobat, for instance, you can go to "File" -> "Properties" -> "Security" to set a password to restrict access or editing capabilities. **Are there any free alternatives to Adobe Acrobat for working with PDFs?** Yes, there are many free alternatives for working with PDFs, such as: LibreOffice: Offers PDF editing features. PDFsam: Allows splitting, merging, and editing PDFs. Foxit Reader: Provides basic PDF viewing and editing capabilities. **How do I compress a PDF file?** You can use online tools like Smallpdf, ILovePDF, or desktop software like Adobe Acrobat to compress PDF files without significant quality loss. Compression reduces the file size, making it easier to share and download. **Can I fill out forms in a PDF file?** Yes, most PDF viewers/editors like Adobe Acrobat, Preview (on Mac), or various online tools allow you to fill out forms in PDF files by selecting text fields and entering information. **Are there any restrictions when working with PDFs?** Some PDFs might have restrictions set by their creator, such as password protection, editing restrictions, or print restrictions. Breaking these restrictions might require specific software or tools, which may or may not be legal depending on the circumstances and local laws.

Find Trx 3honda Work Shop Manual :

writing an article analysis paper

ww2 evacuee name tag template

~~wow leather work guide~~

wow icc raid guide bosses

wyatt return of the cowboy

writing essays for college

writing a project progress report

writing an analytical paper

wvt700t service manual

write short note on korper kappe theory

wz3 16 2 manual**writing womens worlds bedouin stories lila abu lughod**

wrat4 technical manual

ww1 quiz answer sheet**x press 300 repair manual****Trx 3honda Work Shop Manual :****how much do medallion kitchen cabinets cost costowl com** - Sep 03 2023

web jan 13 2022 it is extremely difficult to estimate the price of medallion cabinets the manufacturer does not advertise its prices and the total cost of a project is dependent on a large number of variables product line the size of your kitchen the style of cabinets you select and optional features and upgrades

medallion cabinetry cabinetworks group - Mar 17 2022

web consumer support 1 888 221 3872 medallion cabinetry offers the durable high quality you need with the handcrafted beauty you want something to fit every style space and budget medallion at menards provides a nearly limitless array of styles wood finishes and customizable cabinetry to create built in

medallion kitchen cabinets kitchen reviews - Feb 25 2023

web the cabinets are competitively priced there is choice of a variety of semi custom wood cabinetry in oak maple cherry hickory knotty pine knotty alder and quarter sawn oak unique options include glass doors wine glass holders spice drawers slide out shelves and cookbook racks

medallion cabinetry kitchen cabinets and bath vanities - Oct 04 2023

web create a personal spa with elegant architectural touches on flexible easy to use cabinetry that can be customized to your personal style and tastes designer created kitchen storage organization solutions bathroom vanities with premium furniture inspired details 300 style stain paint options

kitchen cabinet made in turkey hfc custom hotel furniture - Jun 19 2022

web oct 3 2023 low cost our high end custom cabinets are cost effective you get quality cabinets at the lowest prices and guarantee maximum profit kitchen cabinets from turkey are the most affordable compared to other producing countries this is attributed to the technology and bulk production that reduce the cost of final products

medallion at menards cabinets kitchen and bath cabinetry - Oct 24 2022

web for cabinetry that will last a lifetime medallion offers the quality you need with the handcrafted beauty you want something to fit every style space and budget medallion cabinetry works with any size kitchen or bath remodel budget a menards team member will design the right space to fit style and needs

a quick reference guide to medallion s platinum medallion cabinetry - Apr 29 2023

web brand new reflect your own excellent taste with medallion s plentiful offerings with cabinetry styles from classic to cutting edge you ll find doors and finishes that express your own personal flair no matter what you envision find the perfect look here your inspired space awaits 2 medallioncabinetry com

medallion cabinetry quick convenient one click skus - Sep 22 2022

web medallion s stacked cabinets are available in the following heights 48 51 and 54 with a 15 high upper section and 57 and 60 with an 18 high upper section additional door hardware gives the appearance of two cabinets smart sink base cabinet the sink mat protects the cabinet floor from leaks

8 piece istanbul medallion photos ideas houzz - Apr 17 2022

web browse photos of 8 piece istanbul medallion on houzz and find the best 8 piece istanbul medallion pictures ideas

cabinetry medallion kitchens - May 19 2022

web wonder if direct plus can save you any money on cabinets a recent customer was quoted just over 9100 on medallion cabinets by a well known big box store after their extra discount they purchased the exact same cabinets through direct plus for 5400 a savings of 3700

medallion cabinets navigating reviews prices and top tips - Nov 24 2022

web aug 4 2023 this section delves deep into the cost structure of medallion cabinets the variables influencing their pricing and a comparative analysis with other brands overview of the cost of medallion cabinets medallion cabinets known for their craftsmanship and quality presents a diverse price range ensuring that there s something for

medallion cabinetry shop online houzz - May 31 2023

web customer rating assembly price medallion cabinetry clear all sort by relevance customer rating price 6 results rosewood long life display cabinet antique black by oriental furniture 4 998 only 9 left rosewood long life cabinet two tone by oriental furniture 25 840 only 9 left

medallion cabinets vs kraftmaid 2023 in depth differences - Dec 26 2022

web sep 25 2023 are you looking for the best kitchen cabinet around the market and are confused about medallion cabinets and kraftmaid then this blog post is designed for you from this blog post you will get to know about a detailed comparison between medallion cabinets vs kraftmaid cabinets so that you pick the

how can i get a spce book for medallion cabinetry houzz - Feb 13 2022

web example your list price might be 20 167 and their retail multiplier might be 63 so $20\ 167 \times 63 = 12\ 705\ 21$ retail selling price the multiplier is determined by the dealer s cost multiplier which can be different for each dealer depending on

medallion cabinetry brochures - Aug 02 2023

web medallion bath silhouettes view cabinetry care cleaning download pdf medallion warranty information platinum gold silverline hardware catalog view download

medallion cabinets vs kraftmaid 2023 in depth differences - Jul 21 2022

web aug 29 2023 though both medallion cabinets and kraftmaid come with significant pricing kraftmaid cabinets cost less compared to medallion cabinets due to this factor some users say they ended up purchasing kraftmaid cabinets

kitchenreviews com reviews of medallion cabinets - Aug 22 2022

web read reviews of medallion cabinets 56 reviews by homeowners renters landlords contractors and distributors kitchen cabinet and appliance reviews

medallion cabinetry kitchens rated - Jan 27 2023

web medallion cabinetry elkay manufacturing company 2222 camden court oak brook il 60523 1 800 476 4181 view website company info reviews 13

medallion cabinetry budget - Jul 01 2023

web good budgeting is the key to making your dream kitchen a reality make a list of all new room features then prioritize them for potential trade offs we recommend allocating budget dollars by category as a percent of the total budget knowing that a full featured large scale room will cost more than a small scale room

medallion cabinetry difference - Mar 29 2023

web silverline medallion silverline cabinetry combines practical function with elegant design add value to your home with quality products in our most sought after styles platinum luxury style

answers for ipc physics final re vocab pdf oldcove - Oct 27 2022

web answers for ipc physics final re vocab gale directory of databases 2000 integrated physics and chemistry chapter 5 activities paradigm accelerated curriculum 2005 01

ipc physics final re vocabulary answers pdf waptac - Jul 04 2023

web ipc physics final re vocabulary answers ipc physics final re vocabulary answers 3 downloaded from waptac org on 2019 06 16 by guest lessons this course

































ipc physics final re vocab answer key copy wp publish - Nov 27 2022

web ipc physics final re vocab answer key decoding ipc physics final re vocab answer key revealing the captivating potential of verbal expression in a period characterized

ipc physics final review vocabulary answers pdf uniport edu - Jan 18 2022

web jul 22 2023 ipc physics final review vocabulary answers 1 9 downloaded from uniport edu ng on july 22 2023 by guest ipc physics final review vocabulary

full forms hindi ipc full form hindi - Mar 20 2022

web      ipc                             

ipc physics final review vocabulary answers copy uniport edu - Dec 17 2021

web jul 28 2023 ipc physics final review vocabulary answers 2 8 downloaded from uniport edu ng on july 28 2023 by guest her king a man seen in vision and fated to be

ipc physics final review vocabulary answers uniport edu - Aug 25 2022

web jun 14 2023 ipc physics final review vocabulary answers 2 9 downloaded from uniport edu ng on june 14 2023 by guest nuclear energy rutherford becquerel marie

ipc physics final review vocabulary answers 2023 stage gapinc - Apr 20 2022

web ipc physics final review vocabulary answers downloaded from stage gapinc com by guest wilson sariah interpersonal communication book john wiley sons new

ipc final exam flashcards quizlet - Apr 01 2023

web this energy is created by moving electrical particles mechanical energy examples of this type of energy are water wind sound blood flow and walking heat energy this type of

ipc physics final review vocabulary answers pdf uniport edu - Feb 28 2023

web may 1 2023 ipc physics final review vocabulary answers 1 8 downloaded from uniport edu ng on may 1 2023 by guest ipc physics final review vocabulary

ipc physics final re vocabulary answers pdf cpanel urbnleaf - May 22 2022

web oct 6 2023 ipc physics final re vocabulary answers ipc physics final re vocabulary answers 2 downloaded from cpanel urbnleaf com on 2021 06 27 by guest

ipc physics final review vocab cstephenmurray com - Aug 05 2023

web ipc physics final review vocab chapter 1 and 2 speed and acceleration 1 variable 2 experiment 3 data table 4 trial 5

procedure a one time an experiment is run how

[ipc physics final review vocabulary answers pdf uniport edu](#) - Jun 03 2023

web jul 11 2023 ipc physics final review vocabulary answers is available in our digital library an online access to it is set as public so you can download it instantly our book servers

ipc physics final review vocabulary answers copy uniport edu - Nov 15 2021

web jul 26 2023 ipc physics final review vocabulary answers 1 8 downloaded from uniport edu ng on july 26 2023 by guest
ipc physics final review vocabulary

answers for ipc physics final re vocab pdf - Sep 25 2022

web oct 11 2023 answers for ipc physics final re vocab pdf interactivearchivist archivists org subject answers for ipc physics final re

ipc physics final review vocab flashcards quizlet - Oct 07 2023

web standing wave a wave that is trapped within boundaries has nodes and antinodes harmonic a wave that is a multiple of another wave wavelength the length of one

ipc physics final review vocabulary answers pdf uniport edu - May 02 2023

web jul 28 2023 ipc physics final review vocabulary answers 2 8 downloaded from uniport edu ng on july 28 2023 by guest
the big red book of spanish vocabulary

[ipc physics final review vocab answer key 2022](#) - Jun 22 2022

web ipc physics final review vocab answer key 3 3 their choice a framework for k 12 science education is the first step in a process that can inform state level decisions and

answers for ipc physics final review vocab a be220 - Jul 24 2022

web integrated physics and chemistry ipc answer key units 1 10 res integrated physics and chemistry ipc unit 10 res
integrated physics and chemistry ipc unit 6

final vocab review answer key pdf scribd - Sep 06 2023

web 1 weight b an action that can causes motion 2 friction force pulling all object toward each ater slit 4 eesti a the fc
pvityon an obit ay force that resist motion causes heat

ipc physics final review vocabulary answers download only - Dec 29 2022

web ipc physics final review vocabulary answers right here we have countless book ipc physics final review vocabulary
answers and collections to check out we

ipc definition of ipc by the free dictionary - Feb 16 2022

web meanwhile the ipc offered compensation for the remaining properties corresponding to only 14 of their estimated

market value

[ipc physics final review vocabulary answers download only](#) - Jan 30 2023

web ipc physics final review vocabulary answers 1 ipc physics final review vocabulary answers yeah reviewing a book ipc physics final review vocabulary answers

[gregs tagebuch schulerkalender 2016 2017 pdf](#) - Aug 09 2022

web gregs tagebuch schulerkalender 2017 2018 4 web feb 23 2023 merely said the gregs tagebuch schulerkalender 2017 2018 is universally compatible in imitation of any devices to read diary of dorkius maximus tim collins 2013 02 07 dorkius maximus is a young boy growing up in 2016 05 10 when

[gregs tagebuch schülerkalender 2017 2018 amazon de](#) - Mar 16 2023

web may 6 2017 gregs tagebuch schülerkalender 2017 2018 kinney jeff amazon de books skip to main content de hello select your address books hello sign in account lists

gregs tagebuch als ebooks unkonventioneller lesespaß - Jun 07 2022

web 1 ihr gutschein blackweek gilt bis einschließlich 27 11 2023 sie können den gutschein ausschließlich online einlösen unter ebook de der gutschein ist nicht gültig für gesetzlich preisgebundene artikel deutschsprachige bücher und ebooks sowie für preisgebundene kalender tonieboxen tolino ereader tolino select sowie folgende

[gregs tagebuch schulerkalender 2017 2018 pdf uniport edu](#) - Nov 12 2022

web sep 2 2023 right here we have countless ebook gregs tagebuch schulerkalender 2017 2018 and collections to check out we additionally pay for variant types and as a consequence type of the books to browse

gregs tagebuch schulerkalender 2017 2018 wrbb neu - May 18 2023

web checking out a ebook gregs tagebuch schulerkalender 2017 2018 next it is not directly done you could understand even more almost this life roughly the world we pay for you this proper as competently as easy mannerism to get those all we provide gregs tagebuch schulerkalender 2017 2018 and numerous book collections from fictions to

[gregs tagebuch schülerkalender 2017 2018 calendar](#) - Sep 22 2023

web gregs tagebuch schülerkalender 2017 2018 kinney jeff amazon com au books

[gregs tagebuch schulerkalender 2016 2017](#) - Apr 17 2023

web gregs tagebuch schulerkalender 2016 2017 börsenblatt jul 15 2021 diary of a wimpy kid 11 double down mar 23 2022 vollständiges bücher lexicon enthaltend alle von 1750 bis zu ende des jahres 1832 1910 in deutschland und in den angrenzenden ländern gedruckten bücher jul 03 2020 schülerkalender und informationen apr 04 2023

[gregs tagebuch schülerkalender 2017 2018 amazon com](#) - Jul 20 2023

web dimensions 6 34 x 4 13 x 0 51 inches isbn 10 3833958804 isbn 13 978 3833958809 see all details the amazon book

review book recommendations author interviews editors picks and more read it now product details

gregs tagebuch schülerkalender 2016 2017 by jeff kinney - Dec 01 2021

web hausaufgabenheft billig finden online book library gregs tagebuch schülerkalender 2017 2018 von jeff kinney

schülerkalender 2017 2018 a5 bewertungen amp preise 2020 schülerkalender 2020 2021 bei bücher de portofrei kaufen

die buchreihe gregs tagebuch in richtiger reihenfolge - Jan 02 2022

web gregs tagebuch alle bücher in richtiger reihenfolge llll informationen zum autor beliebte bücher bestseller

empfehlungen richtige reihenfolge

gregs tagebuch schülerkalender 2017 2018 calendar - Jun 19 2023

web buy gregs tagebuch schülerkalender 2017 2018 by isbn 9783833958809 from amazon s book store everyday low prices and free delivery on eligible orders

gregs schule die junior highschool gregs tagebuch wikidot - Apr 05 2022

web mit dem begriff junior highschool sind meistens die klassenstufen 7 und 8 gemeint die eigentliche highschool beinhaltet

dann in der regel die klassenstufen 9 bis 12 die schüler und schülerinnen einer highschool müssen sogenannte pflichtkurse

belegen und können je nach interesse sich für eine bestimmte anzahl an wahlkursen entscheiden

gregs tagebuch schülerkalender 2016 2017 by jeff kinney - Feb 03 2022

web jun 6 2023 latest debuted gregs tagebuch schülerkalender 2016 2017 by jeff kinney is obtainable in our novel

gathering an online access to it is set as public so you can get it instantaneously

gregs tagebuch schülerkalender 2017 2018 by jeff kinney - Oct 23 2023

web gregs tagebuch schülerkalender 2017 2018 von jeff kinney schülerkalender amp schulplaner 2020 online kaufen thalia suchergebnis auf de für schülerkalender kalender

gregs tagebuch schülerkalender 2017 2018 copy wrbb neu - Dec 13 2022

web it will completely ease you to see guide gregs tagebuch schülerkalender 2017 2018 as you such as by searching the title

publisher or authors of guide you in fact want you can discover them rapidly

gregs tagebuch schülerkalender 2016 2017 by jeff kinney - Feb 15 2023

web this gregs tagebuch schülerkalender 2016 2017 by jeff kinney as one of the predominant running sellers here will

entirely be accompanied by the best alternatives to review if you want to amusing fiction lots of books fable gags and more

fictions collections are also launched from best seller to one of

gregs tagebuch schülerkalender 2021 2022 taschenbuch amazon de - Jul 08 2022

web gregs tagebuch schülerkalender 2021 2022 kinney jeff isbn 9783833958939 kostenloser versand für alle bücher mit

versand und verkauf duch amazon

die besten gregs tagebücher bücher und filme dad s life - Mar 04 2022

web gregs tagebuch 1 von idioten umzingelt von jeff kinney baumhaus verlag wer neu mit gregs abenteuern startet greift am besten auf diesen titel zurück er ist der erste band der reihe und steht sogar auf platz 1 der new york times bestsellerliste gregs tagebücher sind für kinder ab zehn jahren geeignet 16 00 eur

free gregs tagebuch schulerkalender 2016 2017 - Oct 11 2022

web gregs tagebuch schulerkalender 2016 2017 schülerkalender art 2016 17 dec 02 2022 streifen floral schülerkalender a5 kalender 2022 sep 06 2020 was ist was schülerkalender 2008 2009 apr 06 2023 fögl d engiadina oct 20 2021 diary of a wimpy kid 12 the getaway apr 25 2022

gregs tagebuch schulerkalender 2016 2017 pdf copy election - May 06 2022

web gregs tagebuch schulerkalender 2016 2017 pdf introduction gregs tagebuch schulerkalender 2016 2017 pdf copy the meltdown jeff kinney 2018 when snow closes greg heffley s middle

ebook gregs tagebuch schulerkalender 2016 2017 - Sep 10 2022

web gregs tagebuch schulerkalender 2016 2017 schülerkalender und informationen dec 19 2022 es handelt sich um einen schülerkalender für die weiter führende schule sowie studium es beinhaltet ein notfallplan name anschrift telefon gesundheit emotion schule ziele hausarbeit taschengeld freunde

gregs tagebuch schulerkalender 2017 2018 2022 e - Jan 14 2023

web 2 gregs tagebuch schulerkalender 2017 2018 2021 07 25 gregs tagebuch schulerkalender 2017 2018 2021 07 25 jacobs braiden tickle my ears penguin uk the robber hotzenplotz is a merry tale of two scoundrels two friends a toad fairy and an unforgettable escapade the robber hotzenplotz works hard at his job waking early to

gregs tagebuch schulerkalender 2017 2018 pdf pdf - Aug 21 2023

web gregs tagebuch schulerkalender 2017 2018 pdf in a world consumed by screens and the ceaseless chatter of instant transmission the melodic elegance and psychological symphony created by the written term often disappear in to the back ground eclipsed by the relentless noise and disturbances that permeate our lives